

**FAGOR DRO**

**NV-300T**

**NV-301T**

**INSTALLATION MANUAL**

**Man: 9910 Soft: 2.xx**



# INDEX

<b>Introduction .....</b>	<b>1</b>
Declaration of conformity .....	2
Safety conditions .....	3
Warranty terms .....	5
Material returning terms .....	6
<b>1. Unit description .....</b>	<b>7</b>
1.1 Front panel .....	7
1.2 Rear panel .....	10
1.3 General characteristics .....	11
<b>2. Connections .....</b>	<b>12</b>
2.1 connection of the feedback systems .....	12
2.2 Power and machine connection .....	13
2.3 Turning the unit on and off .....	13
<b>3. Parameter setting .....</b>	<b>14</b>
3.1 Parameters to configure axis count and display .....	16
<b>Appendix .....</b>	<b>20</b>
Error codes .....	20
Maintenance .....	21

## INTRODUCTION

### **Attention:**



Before starting up the DRO, carefully read the instructions of Chapter 2 in the Installation Manual.

The DRO must not be powered-on until verifying that the machine complies with the "89/392/CEE" Directive.

## DECLARATION OF CONFORMITY

**Manufacturer: Fagor Automation, S. Coop.**

**Barrio de San Andrés s/n, C.P. 20500, Mondragón -Guipúzcoa  
(ESPAÑA)**

We hereby declare, under our responsibility that the product:

**Digital Readout (DRO) Fagor NV-300T / NV-301T**

meets the following directives:

### **SAFETY:**

EN 60204-1 Machine safety. Electrical equipment of the machines.

### **ELECTROMAGNETIC COMPATIBILITY:**

EN 50081-2 Emission

EN 55011 Radiated. Class A, Group 1.  
EN 55011 Conducted. Class A, Group 1.

EN 50082-2 Immunity

EN 61000-4-2 Electrostatic Discharges.  
EN 61000-4-3 Radiofrequency Radiated Electromagnetic Fields  
EN 61000-4-4 Bursts and fast transients.  
EN 61000-4-5 Power surges  
EN 61000-4-6 Conducted disturbance induced by radio  
frequency fields.  
EN 61000-4-11 Voltage fluctuations and Outages.

ENV 50204 Electromagnetic fields radiated by wireless telephones.

As instructed by the European Community Directives on Low Voltage: 73/23/EEC, (and the 93/68/EEC amendment) on Machine Safety 89/392/EEC and 89/336/EEC on Electromagnetic Compatibility.

In Mondragón, on April 1st, 1996

Fagor Automation, S. Coop. Ltda.  
Director Gerente

Fdo.: Julen Busturia

## **SAFETY CONDITIONS**

Read the following safety measures in order to prevent damage to personnel, to this product and to those products connected to it.

Fagor Automation shall not be held responsible for any physical or material damage derived from the violation of these basic safety regulations.



### **Do not manipulate the inside of the unit**

Only personnel authorized by Fagor Automation may manipulate the inside of this unit.



### **Do not manipulate the connectors with the unit connected to AC power.**

Before manipulating the connectors (mains, feedback, etc.) make sure that the unit is not connected to AC power.

### **Use proper Mains AC power cables**

To avoid risks, use only the Mains AC cables recommended for this unit.

### **Avoid electrical overloads**

In order to avoid electrical discharges and fire hazards, do not apply electrical voltage outside the range indicated in chapter 2 of this manual

### **Ground connection**

In order to avoid electrical discharges, connect the ground terminals of all the modules to the main ground terminal. Before connecting the inputs and outputs of this unit, make sure that all the grounding connections are properly made.

### **Before powering the unit up, make sure that it is connected to ground**

In order to avoid electrical discharges, make sure that all the grounding connections are properly made.

### **Ambient conditions**

Respect the temperature and humidity ranges specified on the chapter about technical characteristics in this manual (1.3).

### **Do not work in explosive environments**

In order to avoid risks, damage, do not work in explosive environments.

## Working environment

This unit is ready to be used in Industrial Environments complying with the directives and regulations effective in the European Community

## Install the unit in the right place

It is recommended, whenever possible, to instal the DRO so its power switch of the back panel is at a distance between 0.7 m (27.5 inches) and 1.7 m (5.6 ft) off the floor and away from direct sunlight, hot air, coolants, chemical products, blows as well as from relays, or high electromagnetic fields (about 0.5m or 20 inches) that could damage it.

This unit complies with the European directives on electromagnetic compatibility. Nevertheless, it is recommended to keep it away from sources of electromagnetic disturbance such as.

- Powerful loads connected to the same AC power line as this equipment.
- Nearby portable transmitters (Radio-telephones, Ham radio transmitters).
- Nearby radio / TC transmitters.
- Nearby arc welding machines.
- Nearby High Voltage power lines.
- Disturbance generating elements of the machine.
- Etc.

## Safety symbols

### Symbols which may appear on the manual



WARNING. symbol

It has an associated text indicating those actions or operations may hurt people or damage products.

### Symbols that may be carried on the product



WARNING. symbol

It has an associated text indicating those actions or operations may hurt people or damage products.



"ELECTRICAL SHOCK" symbol

It indicates that point may be under electrical voltage



"GROUND PROTECTION" symbol

It indicates that point must be connected to the main ground point of the machine as protection for people and units.

## **WARRANTY TERMS**

### **WARRANTY**

All products manufactured or marketed by Fagor Automation has a warranty period of 12 months from the day they are shipped out of our warehouses.

The mentioned warranty covers repair material and labor costs, at FAGOR facilities, incurred in the repair of the products.

Within the warranty period, Fagor will repair or replace the products verified as being defective.

FAGOR is committed to repairing or replacing its products from the time when the first such product was launched up to 8 years after such product has disappeared from the product catalog.

It is entirely up to FAGOR to determine whether a repair is to be considered under warranty.

### **EXCLUDING CLAUSES**

The repair will take place at our facilities. Therefore, all shipping expenses as well as travelling expenses incurred by technical personnel are NOT under warranty even when the unit is under warranty.

This warranty will be applied so long as the equipment has been installed according to the instructions, it has not been mistreated or damaged by accident or negligence and has been manipulated by personnel authorized by FAGOR.

If once the service call or repair has been completed, the cause of the failure is not to be blamed the FAGOR product, the customer must cover all generated expenses according to current fees.

No other implicit or explicit warranty is covered and FAGOR AUTOMATION shall not be held responsible, under any circumstances, of the damage which could be originated.

### **SERVICE CONTRACTS**

Service and Maintenance Contracts are available for the customer within the warranty period as well as outside of it.

## **MATERIAL RETURNING TERMS**

When returning the DRO, pack it in its original package and with its original packaging material. If not available, pack it as follows:

- 1.- Get a cardboard box whose three inside dimensions are at least 15 cm (6 inches) larger than those of the unit. The cardboard being used to make the box must have a resistance of 170 Kg (375 lb.).
- 2.- When sending it to a Fagor Automation office for repair, attach a label indicating the owner of the unit, person to contact, type of unit, serial number, symptom and a brief description of the problem.
- 3.- Wrap the unit in a polyethylene roll or similar material to protect it.
- 4.- Pad the unit inside the cardboard box with poly-etherane foam on all sides.
- 5.- Seal the cardboard box with packing tape or industrial staples.

## 1. UNIT DESCRIPTION

This NV-300T / NV-301T DRO is designed for industrial environments, especially on lathes

It can display the position of two axes or one axis and the combination of the second axis with a third one.

### 1.1 FRONT PANEL

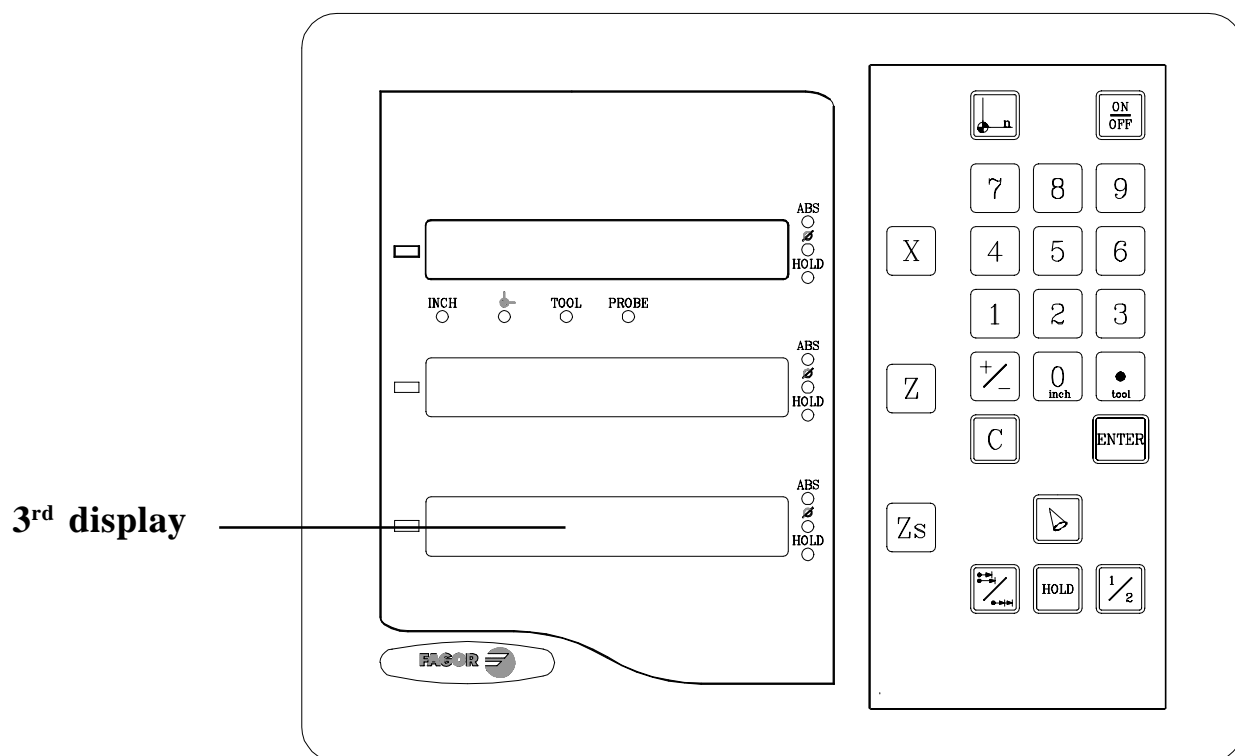



Each axis display has eight 14.1mm high LEDs and another one for the minus sign (-).

**ABS**-This lamp stays on when operating in absolute mode and off when in incremental mode. To access or quit this mode, use the  key.

**Φ**- This lamp stays on when operating in diameter mode. In this mode, the DRO displays twice the actual axis movement. To access it or quit it, use the  key.

**HOLD**- This lamp comes on when "freezing" the axis position by pressing  and the axis key.

**INCH-** This lamp stays on when working in inches and off when doing it in millimeters. To access it or quit it, press 

 This lamp stays on during machine reference search . To access it or quit it, press  key.

**TOOL-** This lamp stays on when setting the tool.

**"PROBE"** This lamp is not used on this model.

**3<sup>er</sup> display** The rightmost digit shows a "1", a "2" or is off to indicate that the Z axis display (2nd one) corresponds to "Z<sub>1</sub>", "Z<sub>2</sub>" or to the combination of "Z<sub>1</sub>+Z<sub>2</sub>" respectively.

This selection rotates by pressing  . It also shows the text "**tool**" followed by the number of the active tool corresponding to the XZ coordinates shown on the other displays.

  Keys to select the first or second axis respectively.

 Key to select whether the 2nd display corresponds to "Z<sub>1</sub>", "Z<sub>2</sub>" or to the combination of "Z<sub>1</sub>+Z<sub>2</sub>" respectively. Every time this key is pressed, the rightmost digit of the 3rd display rotates from "1" to "2" and off respectively.

 Is used for carrying out the home (reference) search.

 Is used for rotating from the incremental to the absolute mode and vice versa

 Is used to turn the display off while keeping track of the axes position at all times. This key must be pressed before turning the unit's power off by the main switch on the back of the unit.

 Is used to validate an operation.

 Is used to cancel or abort an operation already initiated.

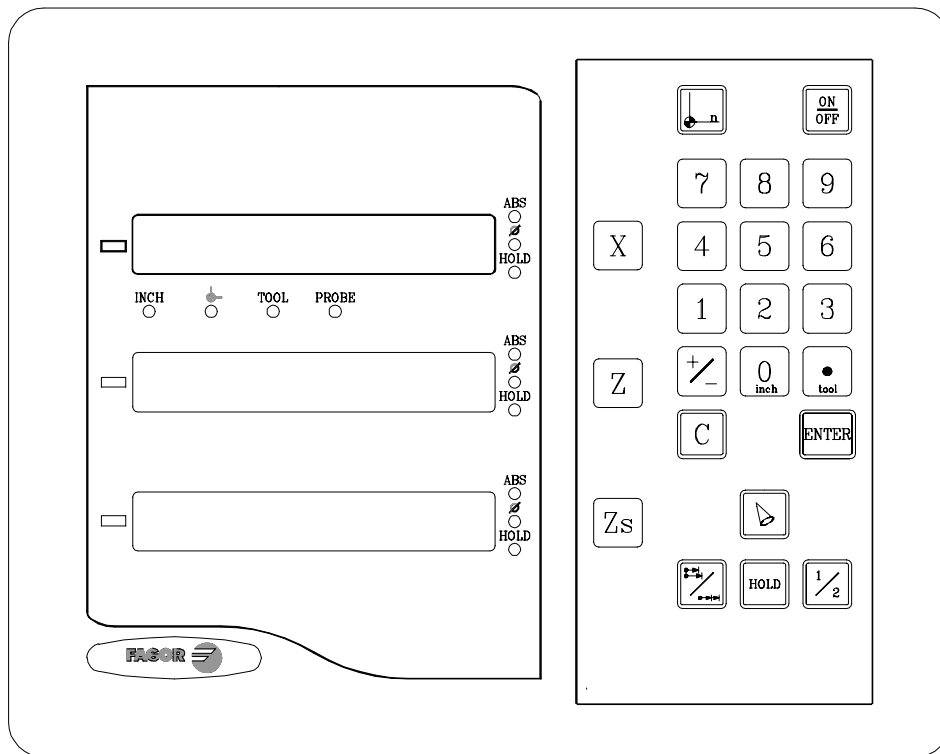

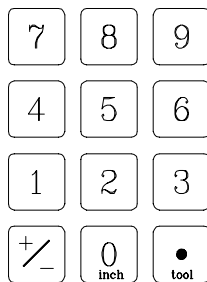

 Is used to display the actual X axis movement or its double.





These keys are used for entering values.

 This one is a dual purpose key and is used for entering values and making a tool change.

 Is used to change the sign of the entered value or change from fine to coarse resolution and vice versa.

 This one is a dual purpose key and is also used to toggle between "millimeters" and "inch" display units.

 Is used for "freezing" the display of the feedback even though the axis moves.

 This key is used for calculating the taper (angle) of a part.

## 1.2 REAR PANEL

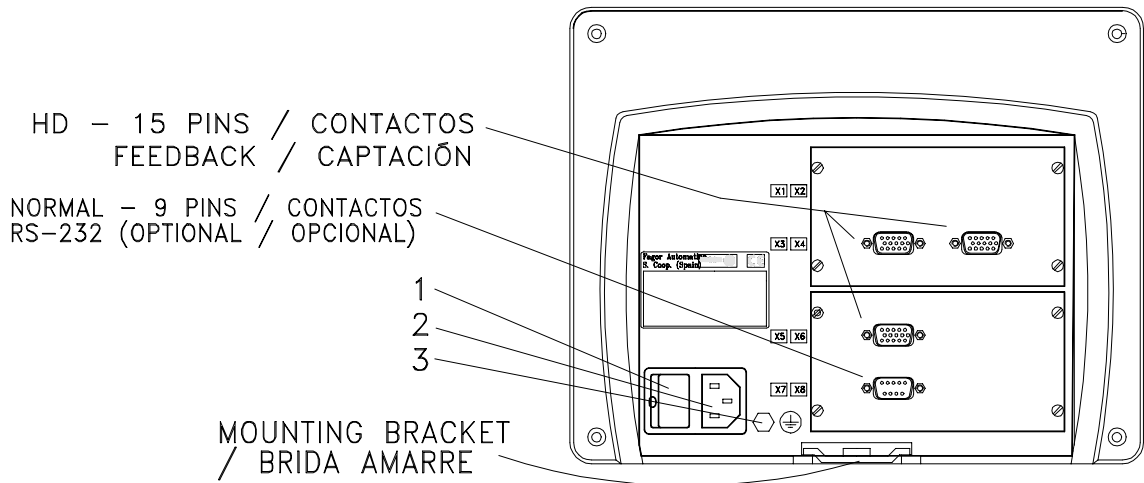

Dimensions of the Built-in model:

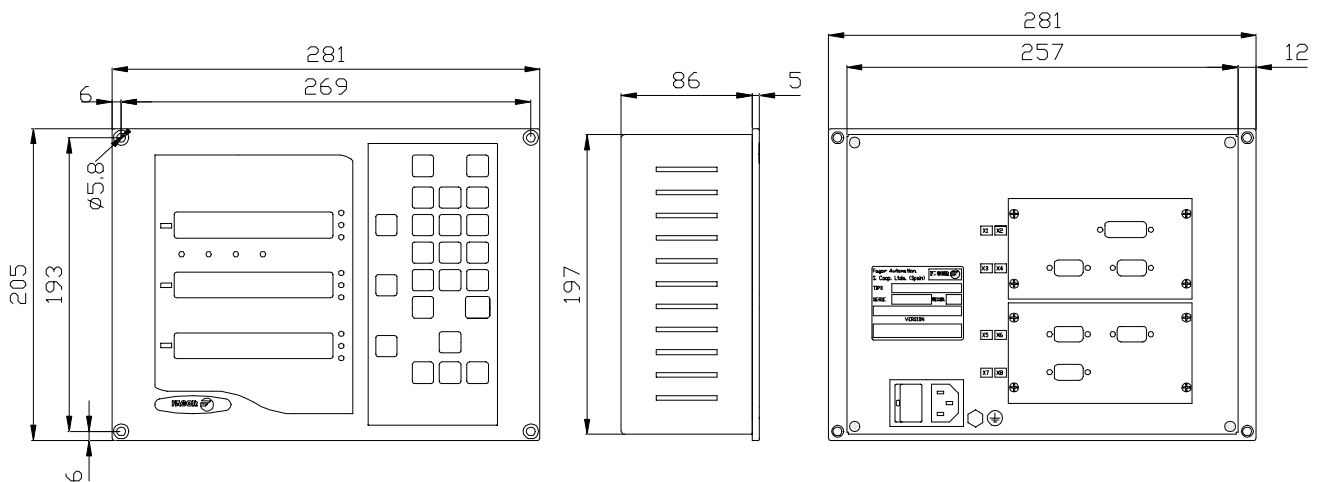

On the back of the unit the following items may be found:

- 1.- Power switch. When the unit is turned off by this switch, the DRO no longer reads axis position. Therefore, it is recommended to use the  ON/OFF key at the front panel to turn the display off so the DRO continues keeping track of the axes position when they are moved.
- 2.- Three-prong power connector for AC and ground connection.
- 3.- M6 mm terminal for general machine ground connection.

Some of the following connectors might not be available depending on specific models:

**X3.-** SUB-D HD type 15-pin female connector for 1st axis feedback device (scale or encoder).

**X4.-** SUB-D HD type 15-pin female connector for 2nd axis feedback device (scale or encoder).

**X5.-** SUB-D HD type 15-pin female connector for 3rd axis feedback device (scale or encoder).

**X7.-** SUB-D type 9-pin male connector for the RS-232-C (Optional).  
**This connector as well as the RS232C option are not described here; but on a supplement for it.**

### **WARNING**



**Do not handle the connectors while the unit is under power.**

Before handling the connectors (mains, feedback, etc.) make sure that the unit is not under power.

It is NOT enough to turn the display off by using the



## ***1.3 GENERAL CHARACTERISTICS***

Universal Power Supply between 100V AC and 240V AC +10% -15%

Mains frequency of 0 Hz (DC) and beteen 45 Hz and 400 Hz

Power outages of up to 20 milliseconds.

10-year memory backup of installation parameters even when the unit is off.

The operating temperature inside the DRO enclosure must be between 5° C and 45° C (41°F and 113°F).

The storage temperature inside the DRO enclosure must be -25° C and +70° C (-13° F and 158° F).

Maximum relative humidity: 95% non condensing at 45°C (113°F).

Front Panel Sealing: IP54 (DIN 40050), Rear panel: IP4X (DIN40050) except for built-in models in which case is: IP20.

## 2. CONNECTIONS

### 2.1 CONNECTION OF THE FEEDBACK SYSTEMS

The feedback systems (scales or encoders) are connected via SUB-D HD type 15-pin female connectors: **X3, X4** and **X5**.

#### Characteristics of feedback inputs: X3, X4 and X5:

- +5V input consumption: 250 mA
- Admits square-wave signal (TTL). (A, B, Io)
- 1Vpp voltage modulated sinewave signals (NV-301T model)
- Maximum frequency: 250 KHz, minimum separation between flanks: 950nsec.
- Phase shift  $90^\circ \pm 20^\circ$ , hysteresis 0.25 V,  $V_{max}$  7V.  
Maximum input current: 3 mA.
- High threshold (logic state 1)  $2.4V \leq V_{IH} \leq 5V$
- Low threshold (logic state 0)  $0.0V \leq V_{IL} \leq 0.8V$

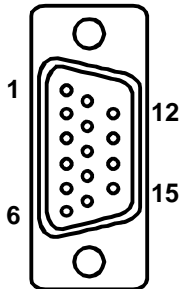

Pin	Signal	Function
1	A	Feedback signals
2	/A*	
3	B	
4	/B*	
5	IO	Reference signal
6	/Io*	
7	Alarm	Feedback alarm
8	/Alarm*	
9	+5V	Power to feedback device
10	Not connected	Unused
11	0V	Power to feedback device
12	Not connected	Unused
13	Not connected	Unused
14	Not connected	Unused
15	Chassis	Shield

\* Not available at the NV-300T model

## 2.2 POWER AND MACHINE CONNECTION

This DRO can be connected to an AC voltage anywhere between 100V AC and 264 V AC +10% -15% with a frequency between 45 Hz and 400 Hz without having to select it depending on the country where they are installed thanks to their universal power supply.

Always mount it vertically so its keyboard is within operator's reach and its digits are easily visible (at operator's eye level).

**Do not connect or disconnect the DRO connectors while it is under power.**

Connect all metallic parts to a common point on the machine tool and it to the general ground point. Use cables of enough gage (no thinner than 8 mm<sup>2</sup>).

## 2.3 TURNING THE UNIT ON AND OFF

### Turning the unit ON



The unit is turned on by actuating on the power switch of the rear panel  
The DRO runs a self-test and shows on the X axis display the text: "**FAGOR dro**" if everything is OK and the error number if otherwise. See the appendix at the end of this manual.

### Turning the unit OFF

If you press  the DRO turns off the displays while maintaining the power supply to the feedback systems and goes on reading the position of the axes at all times. This is not the case when the equipment is switched off by means of the switch on its rear panel.

To reset the displays, just press this key again, on condition that the DRO is getting voltage (plugged in and with the switch on the rear panel on).

### Notes:

- Before powering the DRO down with the switch on the rear panel or disconnecting it from mains, it is a good idea to press the  key in order to store the current position of the axes permanently.
- If the unit is powered down with its rear panel switch or there is a power outage without previously having pressed , the DRO will keep the last position of the axes for at least 30 minutes.
- The unit will display ERROR 2 when powered back up if the position reading was lost when turned off while the axes were moving or after the accidental backup period has expired without having saved the current position by previously pressing .

### 3. *PARAMETER SETTING*

This DRO has a number of installation parameters to configure it for a particular application.

The format for these parameters depends on whether they are general or particular for each axis.

- If it affects the axes, the parameter number (PAR??) appears at each axis and the corresponding axis key must be pressed to modify it.
- If it is a general parameter and there are more than one axis, the **X** display will show the parameter number and the **Z** its current value; if there is only one axis, its number will appear on the **X** display and, after pressing , its value.

There are several kinds of parameters depending on how to set them:

- With binary values. The value of each digit toggles between "0" and "1" when pressing its corresponding key from  to  where  corresponds to the rightmost digit and  to the leftmost one.
- Numeric values, usually with the corresponding axis resolution, they are entered as regular preset.
- Options, the value is changed by pressing  which will make the various options appear in a cyclic way.

**To edit a parameter**, the DRO displays must be on. Then press  .

The X axis display shows the word "**COdE**". Then key in: **060496**

Then, select the axis affected by this parameter.

Once in regular display mode, parameter **PAR05** (scaling factor) may also be recalled by pressing   , so the work mode may be changed without having to go through all the parameters previous to the desired one.

**To go directly to a particular parameter** without going through the previous ones, (once in parameter editing mode) press:

[parameter Nr.] .

**To end editing a parameter**, follow one of these steps:

- . Press , to save the displayed value.
- . Press  to cancel the change and recover the previous value or---
- . Press **the other axis key** (if it is an axis parameter) to save the display value and go on to the editing it for the other axis selected.

**To modify a parameter**, press  to go on to the next one or  to return to the previous one. Then, select the axis affecting this parameter.

**To quit the parameter editing mode:**

Press

**To recover the factory set for the installation parameters:**

While displaying parameter **PAR00**, press:

### 3.1 PARAMETERS TO CONFIGURE AXIS COUNT AND DISPLAY

The digits of digital parameters refer to the digits on the axis displays so digit "1" corresponds to the rightmost digit and "8" to the leftmost digit.

X	X	X	X	X	X	X	X
8	7	6	5	4	3	2	1

#### PARAMETER FUNCTION

- PAR00** Feedback configuration, different for each axis. Binary type.
- Digit
- 8 Direction of the coded Io (**0 = Increasing**, 1 = Decreasing)
  - 7 Pitch of the coded Io (**0 = 20 mm**, 1 = 100mm)
  - 6 Type of linear scale's Io (**0 = Fix**, 1 = Coded)
  - 5 Feedback resolution units (0 = microns, 1= inches)
  - 4 Not being used at this time. Must be set to "0".
  - 3 Differential feedback signals (**0 = No**, 1 = Yes)  
**The NV-300T model cannto be set to "1" (Yes).**
  - 2 Type of feedback signals (**0 = TTL**, 1 = 1 Vpp)  
**The NV-300T model cannto be set to "1" (Vpp).**
  - 1 Counting direction (**0 = normal**, 1 = reverse)  
If an axis count increases or decreases in the opposite direction to the one desired, change the value of this digit.

**PAR01** Feedback resolution. Independent for each axis.  
Possible values: from 0.1µm up to 1 mm (0.000005" to 0.03937").

Factory setting: **5** (µm).

**PAR02** TTL multiplying factor (subdivision). Independent for each axis.  
Options: x4, x2, x1 and x0.5.

The selection of these values rotates by pressing .

The factory setting is: **x4** and it is the one used for FAGOR scales. When using encoders, it should be calculating according to the number of pulses of the encoder, leadscrew pitch and the desired resolution as per the formula:

$$\text{Encoder (lines/turn)} = \frac{\text{Leadscrew pitch (mm/turn)}}{\text{Resolution (mm/pulse)} \times F}$$

Where "xF" would be the multiplying factor to be applied.

**PAR03** External multiplying factor for when using semi-absolute feedback devices (distance-coded Io) or sinewave signals (NV-301T). Independent for each axis.

Options: 1, 5, 10, 20, 25, 50.

**Factory setting: 1**

For example, for FAGOR scales: M0X, C0X or FOT, set this parameter to 5.

**PAR05** Scaling or shrink factor. Independent for each axis, numeric value within ±9,999.

A "0" value means that no factor is to be applied. It is applied onto the coordinates to be displayed after compensating for table sag. It is **not** applied when reading with respect to machine reference zero ( led on).

The factory setting is: "**0**".

**PAR08** Indicates whether the alarms for feedrate, travel limits and feedback will be activated or not.

Digit

- 8, 7, 6 Not being used at this time. Must be set to "0".
- 5 Detect feedback signal weakness on NVxx1 models.
- 4 Value for the feedback alarm contact (0=low, 1=high)
- 3 Detect feedback alarm provided by the scale.
- 2 Detect travel limits (PAR12 and PAR13).
- 1 Detect feedback speed alarma.  
Possible values: 0 (alarms off) and "1" (alarms on).  
Factory values: **0**

The feedback (. . . . .) and travel limit overrun alarms (axis display blinking) will be displayed if the corresponding bit of PAR08 = "1".

The blinking axis error is cleared by returning the axis within its limits

The speed alarm is cleared by pressing .

**PAR09** Axis sag compensation. Independent for each axis.  
Numeric value within  $\pm 99.999$  millimeters per meter.  
Factory setting: **0**.

**Notes:** Even when selecting the display in inches, this value **MUST ALWAYS BE IN MILLIMETERS.**

**1 inch = 25.4 mm**



**PAR10** Offset of the reference point with respect to the reference zero of the scale, independent for each axis.  
Numeric value in resolution units for each axis.  
Factory setting: **0**.

This value will be in mm or inches depending on whether the INCH LED is off or on.

**PAR11** Miscellaneous, binary.

Digit

8, 7, 6, 5, 4, 3, 2 Not being used. Must be set to "0".

- 1 The  key affects one axis (= 0) or both (= 1).  
If it affects by axis, after pressing  one must press the axis key.

It may toggle from absolute reading mode to incremental. This parameter determines whether this toggle affects one axis or both.

Factory setting: "1"

**PAR12** To set the negative axis travel limit.  
Possible values: between -99999.999 and 0.

When the axis exceeds this distance, the corresponding axis display starts blinking until it is moved back into the work zone.

This value will be in mm or inches depending on whether the INCH LED is off or on.

**PAR13** To set the positive axis travel limit.  
Possible values: between 0 and 99999.999

When the axis exceeds this distance, the corresponding axis display starts blinking until it is moved back into the work zone.

This value will be in mm or inches depending on whether the INCH LED is off or on.

**PAR 14** To carry out the home search when the feedback device does NOT have reference marks "Io" (for example, FAGOR MKT scales), this parameter must be set to "1".  
This way it is possible to preset a home value in Machine Reference mode. **Factory setting = "0"**.

# APPENDIX

## **ERROR CODES**

Message	Description
<b>FAGOR dro</b>	Power outage or turned off by main switch after saving the data.
<b>Error 02</b>	Power outage or turned off by main switch without having saved the data. The unit has been turned off without previously pushing the [ON/OFF] key. It will only lose the position count (will be reset to zero) and the status of the operating modes (inch, abs, etc.).
<b>Error 04</b>	Wrong parameter values
<b>Error 05</b>	Wrong internal configuration
<b>Error 06</b>	Errors in data backup memory (Service Dept.)
<b>Error 07</b>	Emergency input active. Press [C] or cancel emergency signal.
<b>Error 08</b>	Wrong software memory or the software has been changed
<b>Error 09</b>	Errors in work memory (Service Dept.)
<b>Error 12</b>	Error while searching a coded marker pulse (Io)
<b>Error 31</b>	Internal malfunction (Service Dept.)
<b>Error 32</b>	Internal malfunction (Service Dept.)
<b>Error 99</b>	Internal malfunction (Service Dept.)
.....	Feedback alarm from the feedback device (scale, encoder, etc) or weak signal.
<b>1.4.3.6.5.7.2.5</b>	Feedback speed too high.
<b>EEEEEEEE</b>	Maximum position reading or speed exceeded when searching Home

If any message other than the first two from the table were to come up, the equipment should be switched off and on again until one of the first two are seen.

After pressing  to access the counting mode, check the parameters.

If any of the errors shown as (Service Department) are often repeated, ask Fagor Automation's Customer Services Department about this.

The feedback alarm error will appear if the bit of the corresponding alarm activating parameter for the axis has been set to "1". **PAR08(1)=1**.

In either case, to clear the display, press .

**If the axis value is flashing**, this means that one of the travel limits established by machine parameter has been exceeded. This error will be displayed if the alarm activation parameter for the axis **PAR08(2) = 1**

If the DRO does not come on or goes out while running, check that the voltage and ground outlets are as they should be. If an axis does not count, disconnect the feedback connectors one by one. If the DRO comes on, it indicates a fault in the feedback device. If the fault persists get in touch with Fagor Automation's Customer Services Department about it.

## ***MAINTENANCE***

### **Cleaning:**

An accumulation of dirt in the equipment can act as a screen preventing proper dissipation of the heat generated by the internal electronic circuits with the consequent danger of overheating and DRO fault.

Accumulated dirt can also, in some cases, provide a conductive path for electricity which could give rise to faults in the internal circuits of the equipment, especially in high humidity conditions.

To clean the equipment nonabrasive dish-washing detergents are recommended (in liquid, never powder form) or 75% isotropic alcohol with a clean cloth. **DO NOT USE** aggressive solvents, (benzol, acetones, etc.) which could damage the materials the equipment is made with.

Do not use high pressure compressed air to clean the item as this could give rise to an accumulation of charges which in turn lead to electrostatic discharges.

The plastics used in the front panel of the DRO stand up to:

1. Grease and mineral oils.
2. Alkalis and bleaches.
3. Dissolved Detergents.
4. Alcohol

Avoid the effect of solvents such as Chlorohydrocarbons, Benzol, Esters and Ethers because these could damage the plastics with which the front of the equipment is made.

### **Preventive Inspection**

If the DRO does not come on press the rear switch for starting, make sure it is properly connected and being supplied with the proper mains voltage.

**FAGOR DRO**

**NV-300T**

**NV-301T**

**OPERATION MANUAL**

**Man: 9910 Soft: 2.xx**



# INDEX

<b>1.</b>	<b>Unit description</b> .....	1
1.1	Front panel .....	1
1.2	Rear panel.....	4
<b>2.</b>	<b>Coordinate display</b> .....	6
2.1	Display modes .....	6
2.2	Incremental, absolute and with respect to machine reference zero .....	7
2.3	Machine reference selection and search .....	9
2.4	Axis coordinate preset .....	11
<b>3.</b>	<b>Special operations</b> .....	13
3.1	Scaling factor .....	13
3.2	Tool Preset .....	14
3.2.1	Deleting all tool offsets .....	14
3.3	Coordinate freeze (Hold) .....	15
3.4	Taper (cone) calculation .....	15
	<b>Appendix</b> .....	16
	Error codes .....	16
	Maintenance .....	17

## ***INTRODUCTION***



Throughout this manual, certain installation parameters are referred to which affect the description of certain DRO functions.

These parameters have been set by the installer and may be modified by the operator.

These parameters are described in the installation manual supplied with this unit.



**INCH-** This lamp stays on when working in inches and off when doing it in millimeters. To access it or quit it, press 

 This lamp stays on during machine reference search . To access it or quit it, press  key.

**TOOL-** This lamp stays on when setting the tool.

**"PROBE"** This lamp is not used on this model.

**3<sup>er</sup> display** The rightmost digit shows a "1", a "2" or is off to indicate that the Z axis display (2nd one) corresponds to "Z<sub>1</sub>", "Z<sub>2</sub>" or to the combination of "Z<sub>1</sub>+Z<sub>2</sub>" respectively.

This selection rotates by pressing  . It also shows the text "**tool**" followed by the number of the active tool corresponding to the XZ coordinates shown on the other displays.

  Keys to select the first or second axis respectively.

 Key to select whether the 2nd display corresponds to "Z<sub>1</sub>", "Z<sub>2</sub>" or to the combination of "Z<sub>1</sub>+Z<sub>2</sub>" respectively. Every time this key is pressed, the rightmost digit of the 3rd display rotates from "1" to "2" and off respectively.

 Is used for carrying out the home (reference) search.

 Is used for rotating from the incremental to the absolute mode and vice versa

 Is used to turn the display off while keeping track of the axes position at all times. This key must be pressed before turning the unit's power off by the main switch on the back of the unit.

 Is used to validate an operation.

 Is used to cancel or abort an operation already initiated.

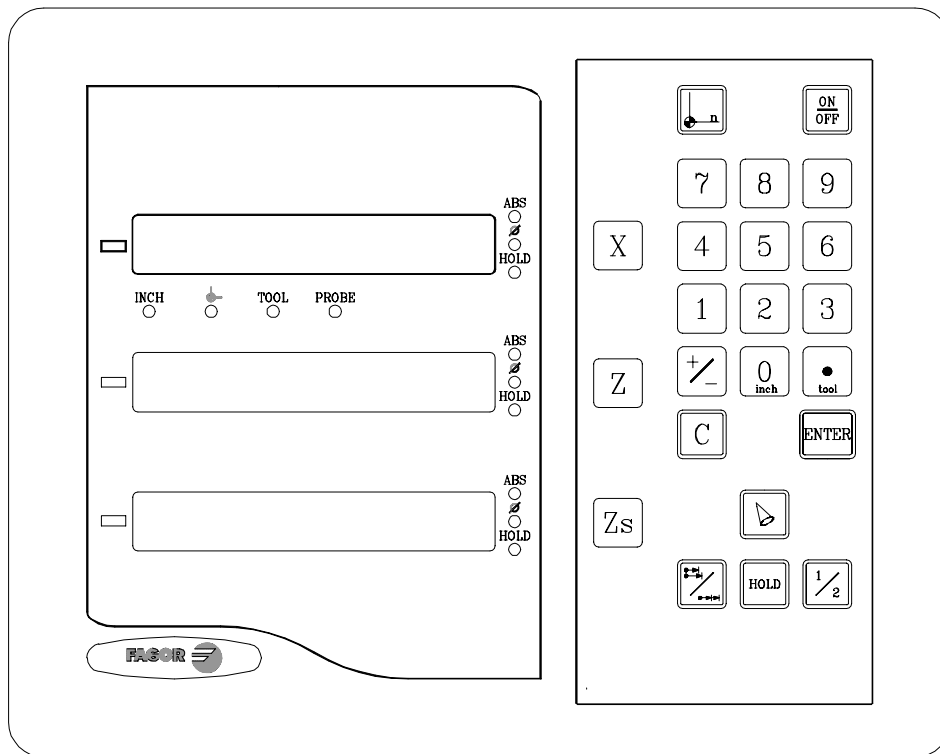

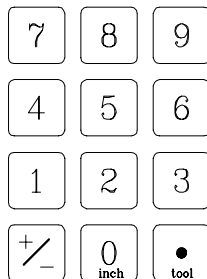

 Is used to display the actual X axis movement or its double.





These keys are used for entering values.

 This one is a dual purpose key and is used for entering values and making a tool change.

 Is used to change the sign of the entered value or change from fine to coarse resolution and vice versa.

 This one is a dual purpose key and is also used to toggle between "millimeters" and "inch" display units.

 Is used for "freezing" the display of the feedback even though the axis moves.

 Is used for calculating the taper (angle) of a part.

## 1.2 REAR PANEL

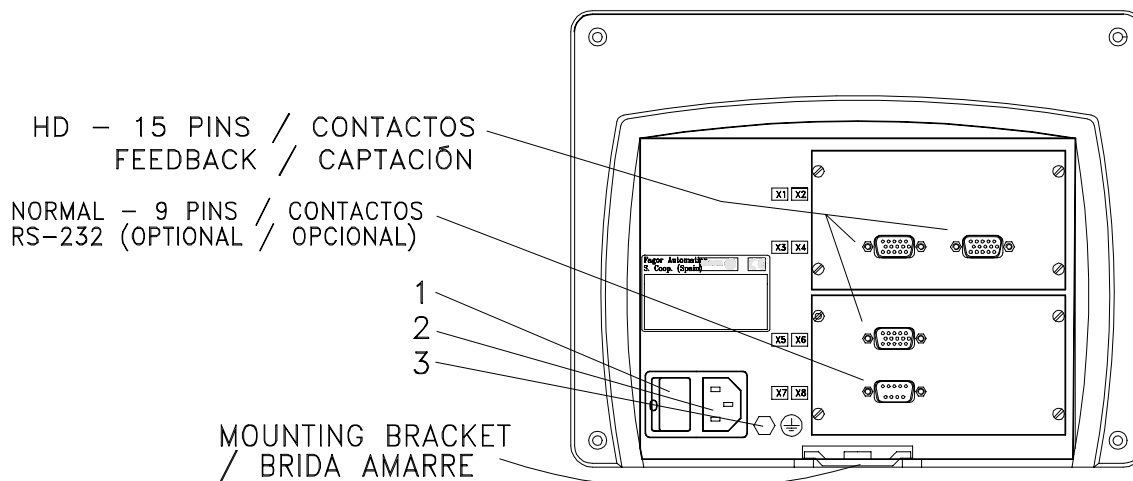

On the back of the unit the following items may be found:

- 1.- Power switch. When the unit is turned off by this switch, the DRO no longer reads axis position. Therefore, it is recommended to use the  key at the front panel to turn the display off so the DRO continues keeping track of the axes position when they are moved.
- 2.- Three-prong power connector for AC and ground connection.
- 3.- M6 mm terminal for general machine ground connection.

Some of the following connectors might not be available depending on specific models:

- X3.-** SUB-D HD type 15-pin female connector for 1st axis feedback device (scale or encoder).
- X4.-** SUB-D HD type 15-pin female connector for 2nd axis feedback device (scale or encoder).
- X5.-** SUB-D HD type 15-pin female connector for 3rd axis feedback device (scale or encoder).
- X7.-** SUB-D type 9-pin male connector for the RS-232-C (Optional).  
**This connector as well as the RS232C option are not described here; but on a supplement for it.**

## WARNING



**Do not handle the connectors while the unit is under power.**

Before handling the connectors (mains, feedback, etc.) make sure that the unit is not under power.

It is NOT enough to turn the display off by using the



## 2. COORDINATE DISPLAY

### 2.1 DISPLAY MODES

#### Turning the unit ON



The unit is turned on by actuating on the power switch of the rear panel. The DRO runs a self-test and shows on the X axis display the text: "**FAGOR dro**" if everything is OK and the error number if otherwise. See the appendix at the end of this manual.

#### Turning the unit OFF

If you press  key the DRO switches off the displays while maintaining the power supply to the feedback systems and goes on reading the position of the axes at all times. This is not the case when the equipment is switched off by means of the switch on the rear panel of the same.

To reset the displays, just press this key again, on condition that the DRO is getting voltage (plugged in and with the switch on the rear panel on).

#### Notes:

- Before powering the DRO down with the switch on the rear panel or disconnecting it from mains, it is a good idea to press the  key in order to store the current position of the axes permanently.
- If the unit is powered down with its rear panel switch or there is a power outage without previously having pressed , the DRO will keep the last position of the axes for at least 30 minutes.
- The unit will display ERROR 2 when powered back up if the position reading was lost when turned off while the axes were moving or after the accidental backup period has expired without having saved the current position by previously pressing .

#### Conversion mm into inches

These DROs let the position of the axes be displayed in millimeters or inches by pressing  key depending on whether the **INCH** led is off or on respectively.

#### Fine / coarse resolution

These DROs allow a decimal digit to be switched off (coarse resolution) for cases in which fine resolution is excessive, simply by pressing .

**For example:** If a counting resolution of 0.005 mm was selected (taking into account the type of scale etc.) by the installation parameter PAR01, it could occur that it is enough for the operator to display every 0.010 mm (0.020, 0.030, etc.) so that the right-hand digit is not required (0.01, 0.02, 0.03, etc.).

**Radius / Diameter:**

With this model, one can display twice the real displacement of the X axis (diameter) by pressing  $\boxed{\frac{1}{2}}$ . Led  $\Phi$  of the X axis will go on or off to indicate the double or real counting mode respectively.

**"Z" axis as a single axis or a combination of two ( $Z_1$  and  $Z_2$ ):**

To display the Z axis position, one or two feedback devices may be used. One for the carriage ( $Z_1$ ) and the other one for the compound ( $Z_2$ ).

When using two feedback devices, the "Z" axis display may show the position of  $Z_1$ , that of  $Z_2$  or the result from combining (adding) the positions of both axes.

To do this, use the  $\boxed{Zs}$  key and every time it is pressed, the rightmost digit of the 3rd display will show a "1" for  $Z_1$ , a "2" for  $Z_2$  or it will turn off to indicate that the displayed "Z" axis value corresponds to the combined position of " $Z_1 + Z_2$ ".

## ***2.2 INCREMENTAL, ABSOLUTE AND WITH RESPECT TO MACHINE REFERENCE ZERO***

This DRO displays the present coordinate of two (XZ) or three axes (X,  $Z_1$ ,  $Z_2$  and  $Z_1+Z_2$ )





Coordinate means the distance from one point or position with respect to another chosen as reference.

This DRO can display the position of the axes in incremental or absolute mode or referring to home.



The lower figure displays the coordinates of an axis which would appear in the different modes:



- In **Incremental (I)**, when the **ABS** and  leds are off the distance from the present position of the axis to the previous position is displayed.

**Note:** On this model, the incremental reading is linked to the absolute so when presetting a new part zero, the incremental zero will also change maintaining the previous distance relative to the part zero.

- In **Absolute (ABS)**, when the **ABS** led is on and the  is off, the distance from the present position of the axis to part zero (**0**) is displayed.
- In **reference zero** () , when  led is on, the distance from the present position of the axis to home (**Io**) chosen in the feedback system (scale or encoder) is displayed. To access this mode use  key.

To change from one of these display modes to another, press  until the relevant led goes on or off as described above.

It could occur that the installation parameter **PAR11(1)** has been set to “**0**” for  key to independently affect each axis so that one axis can display its position in incremental mode while the other does this in absolute. In this case, to change the display mode for a particular axis, press sequence:   for "X" and

  for "Z".

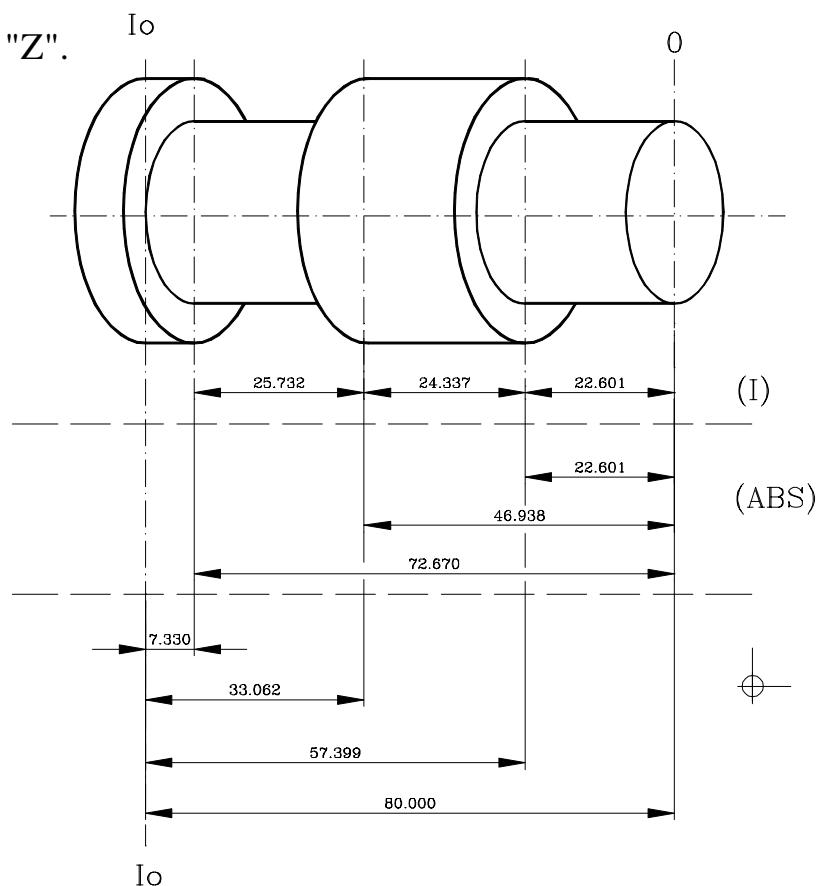

## 2.3 MACHINE REFERENCE SELECTION AND SEARCH

Though it is not absolutely necessary for a large number of applications we recommend fixing a reference point (home) for each axis using the reference marks (Io) of its feedback system, whether this is a scale or an encoder in order to be able to keep the respective zeros (part and incremental) and recover these after having disconnected the equipment or for any other reason.

Standard FAGOR scales have a fixed reference mark (Io) every 50 mm along their travel.

FAGOR also offers scales with a coded Io every 20 mm or every 100 mm (depending on the model) with which all you have to do is move the axis at most 20 mm or 100 mm from the present position in order to “find” the exact position of the axis with respect to home.

When this mode is selected, the DRO waits to receive this pulse (Io) to reestablish all its previous absolute and incremental references (part zero and incremental zero).





For this reason when fixed Io (not coded) scales are used, one first has to choose an approximate reference zone, for example about half way along the axis travel, take the axis up to said zone and carry out the search for the Io (↓) reference mark of the scale (or encoder).

After said (Io) mark has been “found”, following the steps described below, this axis zone is marked with a pen or sticker in order to go back to this in later searches, recommended after having disconnected (not “switched off” the machine, as will be shown later on).

This DRO keeps the relative distance from home (↓) to part zero (**ABS** on) and incremental zero (**ABS** off) for each axis in their internal memory for 10 years even after cutting off their mains power supply, for example, by means of the switch on the rear panel. This means that when it is necessary to reference the axes again, when the Io (home) mark is “found” said absolute and incremental zero values are recovered.

**Note:** In machine reference mode, it will display X, Z<sub>1</sub> and Z<sub>2</sub>.

The home search sequence is as follows:



- Move the axis to the approximate reference zone (roughly).  
**This step is only for fixed Io scales (not coded)**
- Put the DRO in home mode by pressing the  to turn the  led on.
- Select the axis to be referenced by pressing  for X,  for Z<sub>1</sub> and  for Z<sub>2</sub>.

Zeros to the left of the axis display will appear.



- Move the axis until the Io reference pulse is detected, that is, when the zeros on the left hand side of the display for the axis being referenced disappear.

When the reference pulse is received, the DRO presets this point with the value assigned to the installation parameter **PAR10** for this axis. This value is (factory set) default “0”. At the same time it recovers the relative distance from this home to the previously fixed part zero (ABS) and incremental.

When using semi-absolute scales (coded Io), the value assumed is the position with respect to scale zero plus the offset.

- Press  again to switch off the  led and thus quit the home mode. Bear in mind that in reference mode, no other operation besides home searching and axis position display are possible.

## **MACHINE REFERENCE (HOME) SEARCH FOR FEEDBACK WITHOUT REFERENCE MARKS**

When using feedback devices without reference marks (FAGOR MKT scales, for instance) a Home value may be preset or zeroed by pressing  in that mode (led  ON).

To enable this feature, the **new installation parameter PAR14 for each axis** must be set to “1” to indicate that the feedback device for that axis has **no** reference marks (Io).

## 2.4 AXIS COORDINATE PRESET



To reset the axis display, just press: sequence: **C** **X** for "X", and **C** **Z** for "Z".

Using the lower figure, let us imagine we wish to make a part in which three holes have to be drilled with the coordinates stated. It is clear that the blueprint will only reflect the incremental coordinates (I) or the absolute ones (ABS) referring to the part zero (point "0" in the figure) although the DRO also shows them with respect to home (Io).

After referencing the axes, as was described in the previous section, we can make this part in incremental or absolute mode according to whether we chose a type of dimensions (I) or (ABS) of the blueprint.

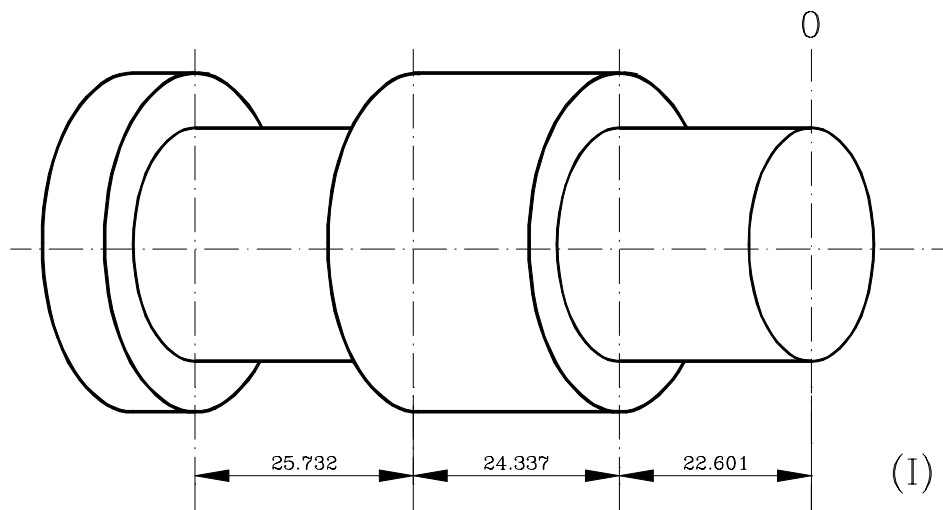
### In incremental mode:



- Press  until the **ABS** led go out and the key  for switching off the  led.
- Move the axis up to corner "D" to set this as part zero.
- At this point, one can proceed in two ways.
  - Preset the axis with zero value by pressing **C** **X**
  - Move the axis to the face of the part until the DRO reads: **022.601**.

or...

- Preset the axis with value **22.601** by pressing:   **22.601**  to validate it.

In case of a mistake, press  to cancel it and leave it as it was.

When pressing , the previously preset value is displayed.

- Move the axis towards the first position until the DRO reads: **0.000**.

This last method turns out to be more practical as after selecting the destination coordinate one only has to remember to move the axis until the DRO reads zero.

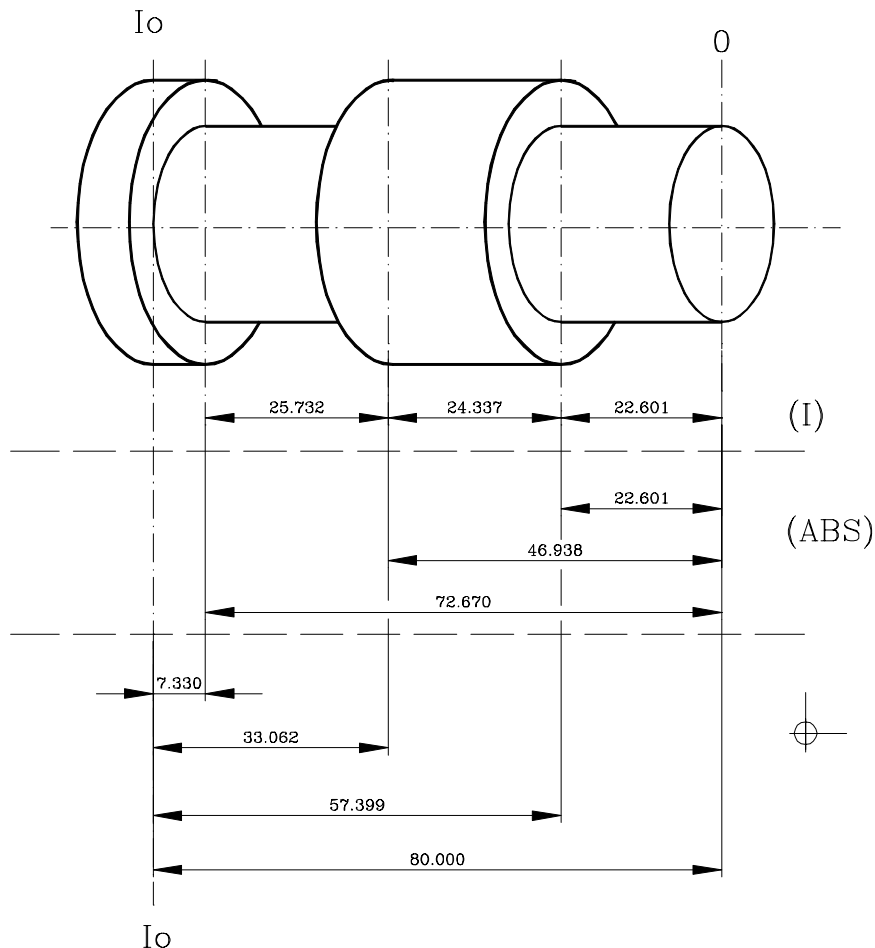

- Once this turning operation has concluded, one can go to the next position, after having preset the next coordinate (**24.337**), by moving the axis until the display reads **0.000**.
- And so on until all the turning operations are concluded.

**Note:** By pressing  until the "ABS" LED lights up, the DRO will show the axis real position with respect to part zero "O"



### In absolute mode:

- Press  until the **ABS** led comes on.
- To preset part zero:
  - Place the axis exactly over “0” and press: **C** **X**

At any time, by pressing key , the DRO will display the present position with respect to the previous zero (**ABS** and  leds off), to part zero (**ABS** led on) or with respect to home ( led on).

The next section describes how preset up to 10 tools.

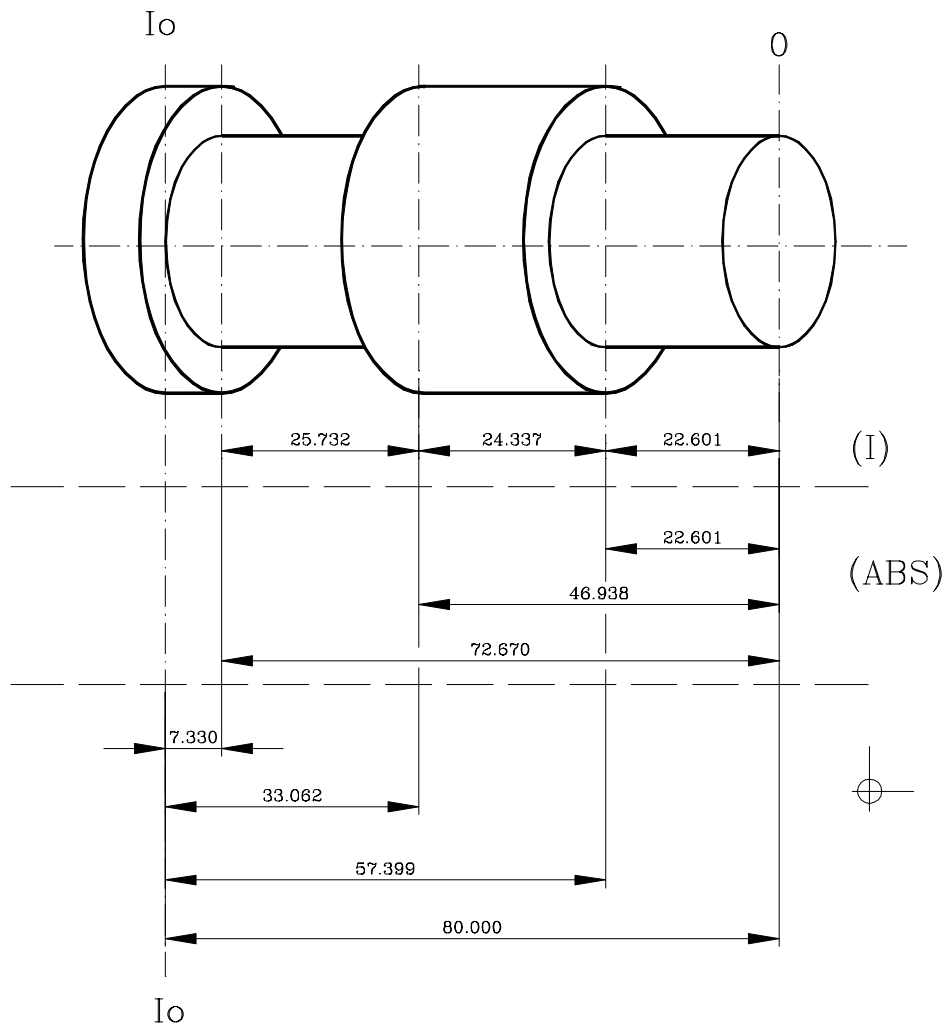

## 3. SPECIAL OPERATIONS

### 3.1 SCALING FACTOR

With this DRO, it is possible to apply a scaling factor between 0 and 9.999 for applications such as mold making by simply keying in (for the X axis, for example): **C** **0** **5** **X** 'value' **ENTER**.



The DRO will then show the axis position resulting from multiplying its real position by the 'value' of the scaling factor.

## 3.2 TOOL PRESET

Up to ten tools may be preset on this DRO model (from "tool 0" to "tool 9"). The unit stores in its internal memory the relative offsets of all the tools with respect to that of "T0".

Therefore, if "T0" has been preset in ABSolute mode (on X and Z) and, then, the rest of the tools, it will suffice to just preset "T0" again (on Z) to make a new part. The DRO will then automatically recalculate all the offsets of the rest of the tools without having to preset them for each part.

To preset a tool, just follow this procedure:

- Place a part of known diameter in the chuck in **ABS**olute mode.
- Move the tool to be preset until it touches the part at the known diameter.
- Press  and the **TOOL** led will come on to indicate that this mode has been selected. The 3rd display will show the word "**tool**" followed by the number of the tool at the time.
- Press the desired number key from "0" to "9".
- Press  to validate this operation or  to cancel it.
- Preset the axes with the contact position of the tool and the known part.

These tool presets are kept in memory even when the unit is powered off up to a maximum of 10 years.

### Notes:

The presets done with any tool in incremental mode change the part zero for all the tools.

If the offset of a tool has been preset in either  $Z_1$ ,  $Z_2$  or  $Z_S$  mode, the same mode ( $Z_1$ ,  $Z_2$  or  $Z_S$ ) must be selected to make a part with it.

### 3.2.1 DELETING ALL TOOL OFFSETS

To delete the offsets of ALL the tools: The  LED must be off.



Press the following key sequence:  . The text: "**Tool = 0?**" will appear.

Press  to validate the operation or  to cancel it.

### 3.3 COORDINATE FREEZE (HOLD)



It enables “freezing” the display of the counter while inside it goes on reading the real position of the axis. This comes about when it is necessary to change the tool and preset the dimension of the new one.

For example, to change a tool at any known point of the part:



- Press key   and the display counting said axis “freezes” at the present value.
- Press key of other axis if you wish to also “freeze” the display of this axis.
- The tool to be replaced withdraws and the new one takes its position.
- The new tool is led to the “freezing” point and the part is touched at said point.
- Press  and the counting “defreezes” starting to count from the previously “frozen” value.

If, in place of this  is pressed, half of the value accumulated since the HOLD function was activated will be taken as present coordinate.

### 3.4 TAPER (CONE) CALCULATION

This DRO calculates the taper angle (cone) of a part by simply touching two of its points and using the  and  keys.

To do this, follow this procedure:

- Move the tool until it touches the part at any point of the taper.
- Press . The displays will start blinking.
- Touch the part with the tool at any other point of the taper.
- Press  so the DRO calculates the angle or  to cancel the operation.

The "X" axis display will show the angle **in ten-thousandths of a degree** (0.0001°) and the "Z" axis display will do so in **degrees, minutes and seconds**.

- Press any key to return to the regular display mode.

# APPENDIX

## **ERROR CODES**

Message	Description
<b>FAGOR dro</b>	Power outage or turned off by main switch after saving the data.
<b>Error 02</b>	Power outage or turned off by main switch without having saved the data. The unit has been turned off without previously pushing the [ON/OFF] key. It will only lose the position count (will be reset to zero) and the status of the operating modes (inch, abs, etc.).
<b>Error 04</b>	Wrong parameter values
<b>Error 05</b>	Wrong internal configuration
<b>Error 06</b>	Errors in data backup memory (Service Dept.)
<b>Error 07</b>	Emergency input active. Press [C] or cancel emergency signal.
<b>Error 08</b>	Wrong software memory or the software has been changed
<b>Error 09</b>	Errors in work memory (Service Dept.)
<b>Error 12</b>	Error while searching a coded marker pulse (Io)
<b>Error 31</b>	Internal malfunction (Service Dept.)
<b>Error 32</b>	Internal malfunction (Service Dept.)
<b>Error 99</b>	Internal malfunction (Service Dept.)
.....	Feedback alarm from the feedback device (scale, encoder, etc) or weak signal.
<b>1.4.3.6.5.7.2.5</b>	Feedback speed too high.
<b>EEEEEEEE</b>	Maximum position reading or speed exceeded when searching Home

If any message other than the first two from the table were to come up, the equipment should be switched off and on again until one of the first two are seen.

After pressing  to access the counting mode, check the parameters.

If any of the errors shown as (Service Department) are often repeated, ask Fagor Automation's Customer Services Department about this.

The feedback alarm error will appear if the bit of the corresponding alarm activating parameter for the axis has been set to "1". **PAR08(1)=1**.

In either case, to clear the display, press .

**If the axis value is flashing**, this means that one of the travel limits established by machine parameter has been exceeded. This error will be displayed if the alarm activation parameter for the axis **PAR08(2) = 1**

If the DRO does not come on or goes out while running, check that the voltage and ground outlets are as they should be. If an axis does not count, disconnect the feedback connectors one by one. If the DRO comes on, it indicates a fault in the feedback device. If the fault persists get in touch with Fagor Automation's Customer Services Department about it.

## ***MAINTENANCE***

### **Cleaning:**

An accumulation of dirt in the equipment can act as a screen preventing proper dissipation of the heat generated by the internal electronic circuits with the consequent danger of overheating and DRO fault.

Accumulated dirt can also, in some cases, provide a conductive path for electricity which could give rise to faults in the internal circuits of the equipment, especially in high humidity conditions.

To clean the equipment nonabrasive dish-washing detergents are recommended (in liquid, never powder form) or 75% isotropic alcohol with a clean cloth. **DO NOT USE** aggressive solvents, (benzol, acetones, etc.) which could damage the materials the equipment is made with.

Do not use high pressure compressed air to clean the item as this could give rise to an accumulation of charges which in turn lead to electrostatic discharges.

The plastics used in the front panel of the DRO stand up to:

1. Grease and mineral oils.
2. Alkalis and bleaches.
3. Dissolved Detergents.
4. Alcohol

Avoid the effect of solvents such as Chlorohydrocarbons, Benzol, Esters and Ethers because these could damage the plastics with which the front of the equipment is made.

### **Preventive Inspection**

If the DRO does not come on press the rear switch for starting, make sure it is properly connected and being supplied with the proper mains voltage.





Display ON / OFF 

MM/Inches 

Fine/Coarse Resolution 

Radius/Diameter (Only X) 



Display Z<sub>1</sub>, Z<sub>2</sub>, Z<sub>S</sub> 



Scaling factor (X)     [Value] 

Incremental/Absolute 



Home reference mode 



Home Search (X)  move axis



Axis preset (X)   [Value] 



1/2 Axis preset (X)   [Value] 

Cancel 

Zero setting (X)  

Coordinate freeze (X).   ... 



Middle point (X).   ... 

Tool selection   a 

Tool preset **Select tool**

**Touch part**

**Preset coordiate**

Delete all tool offsets  

Taper calculation ( $\alpha$ ):

(A) Touch part 

(B) Touch part 

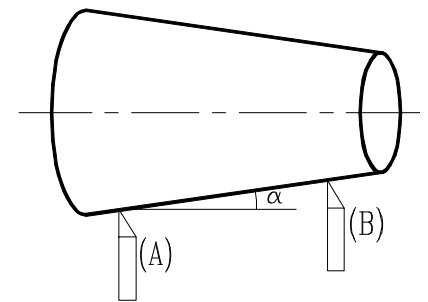

Message	Description
<b>FAGOR dro</b>	Power outage or turned off by main switch after saving the data.
<b>Error 02</b>	Power outage or turned off by main switch without having saved the data. The unit has been turned off without previously pushing the [ON/OFF] key. It will only lose the position count (will be reset to zero) and the status of the operating modes (inch, abs, etc.).
<b>Error 04</b>	Wrong parameter values
<b>Error 05</b>	Wrong internal configuration
<b>Error 06</b>	Errors in data backup memory (Service Dept.)
<b>Error 07</b>	Emergency input active. Press [C] or cancel emergency signal.
<b>Error 08</b>	Wrong software memory or the software has been changed
<b>Error 09</b>	Errors in work memory (Service Dept.)
<b>Error 12</b>	Error while searching a coded marker pulse (Io)
<b>Error 31</b>	Internal malfunction (Service Dept.)
<b>Error 32</b>	Internal malfunction (Service Dept.)
<b>Error 99</b>	Internal malfunction (Service Dept.)
<b>EEEEEEEE</b>	Maximum position reading or speed exceeded when searching Home